

# X-LITE™ trimless

MOUNTING INSTRUCTIONS

## DO NOT DISCARD!

### LEGEND OF THE SIGNS



POWER OFF



POWER ON



DO NOT TOUCH THE LED



ATTENTION



USE ESD GLOVES

### TOOLS REQUIRED (not included)



PENCIL



SCREWDRIVER



DRILL



SCREWS



SPACKLE KNIFE



DRY WALL SAW

### X-Lite™

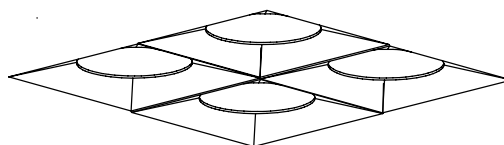

### X-LITE™ TRIMLESS

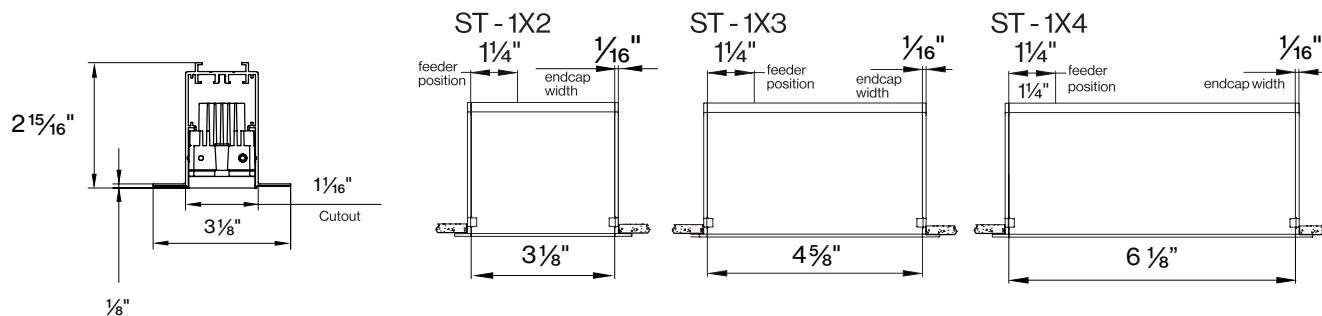

### SN - 1X1

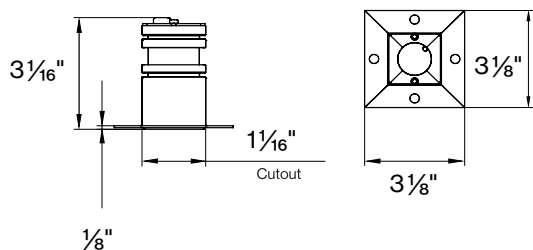

### SQ - 2X2

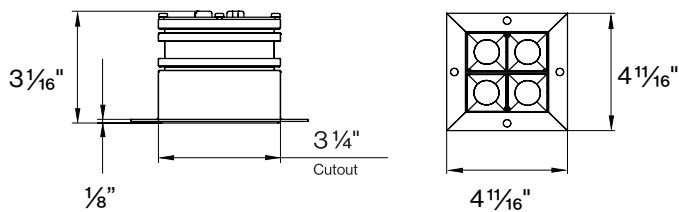



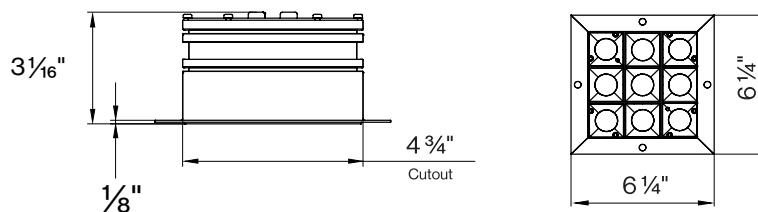



### SQ - 3X3

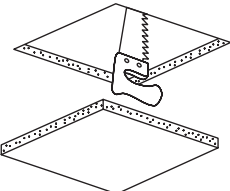

# X-LITE™ trimless

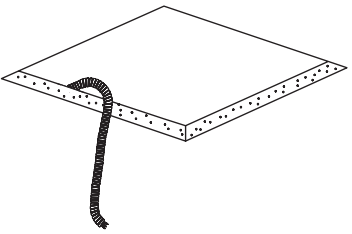
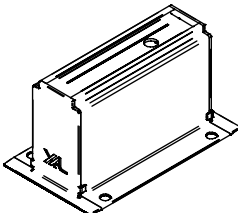
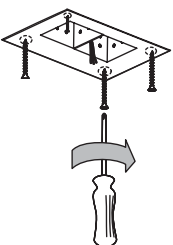
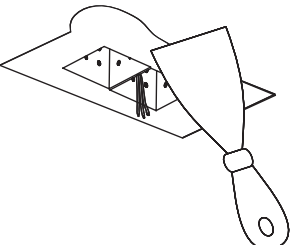
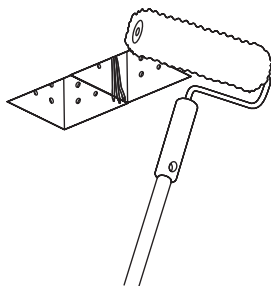
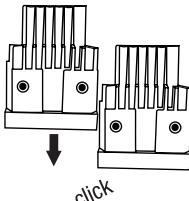
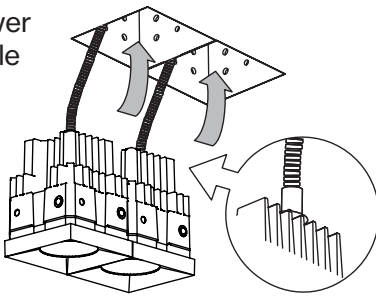
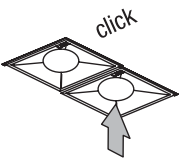
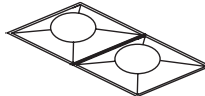
## MOUNTING INSTRUCTIONS

<p>1. Cut out hole in ceiling</p>  <p>*cutout dimension above</p> 	<p>2. Insert blocking into ceiling (supplied by others)</p>  	<p>3. Flex conduit supplied by others</p> 
<p>4. Lift housing to ceiling</p> 	<p>5. Screw fixture to ceiling</p> 	<p>6. Spackle the ceiling around the cutout hole</p> 
<p>7. Paint the ceiling</p> 	<p>8. <b>OPTIONAL:</b> Configurations (see page 1 for different housing options) Slide and click each piece together</p>  <p>click</p>	<p>9. Connect power cable</p> 
<p>10. "Click in" the lamps</p>  <p>click</p>	<p>11. Installation complete</p>   <p>should hear "click" once secure</p>	

## DO NOT DISCARD!

### SIGN LEGEND



### TOOLS REQUIRED (not included)

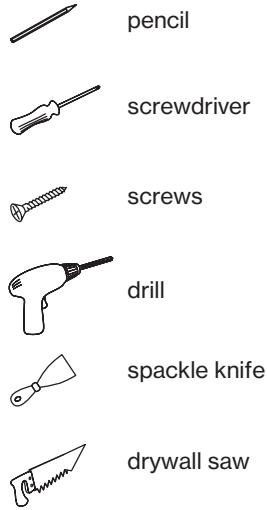

### X-LITE™ TRIM

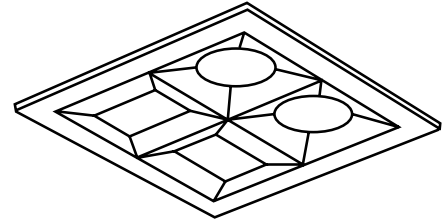

### X-LITE™ TRIM

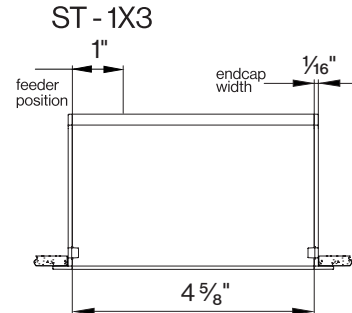
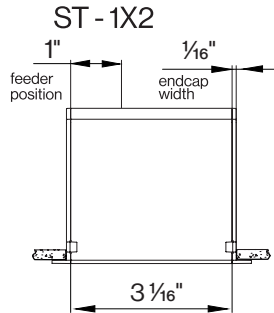
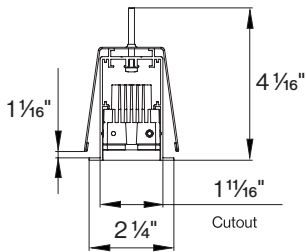

### ST-1X4

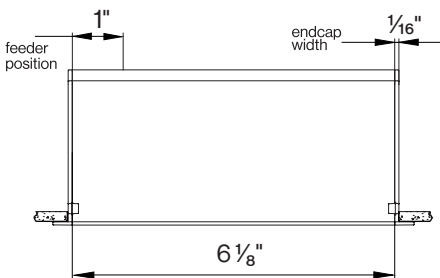

### SN-1X1

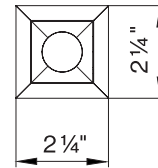
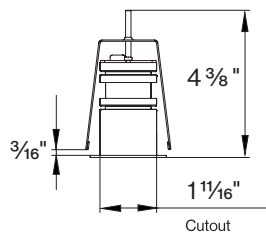

### SQ-2X2

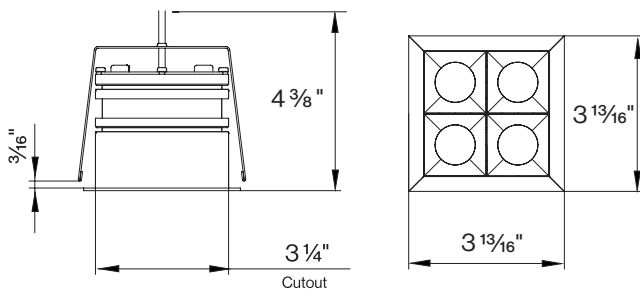

### SQ-3X3

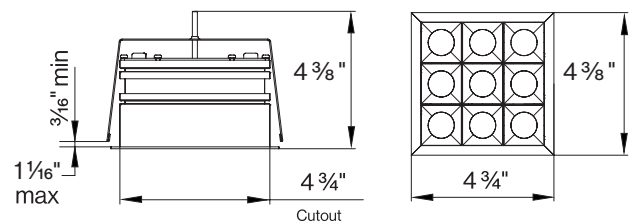

# X-LITE™ trim

## MOUNTING INSTRUCTIONS

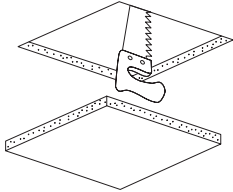
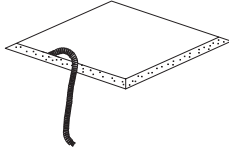
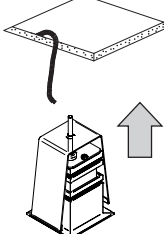
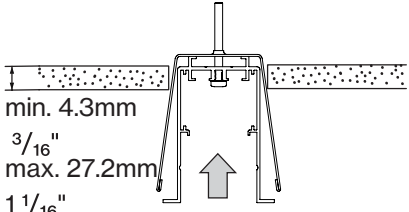
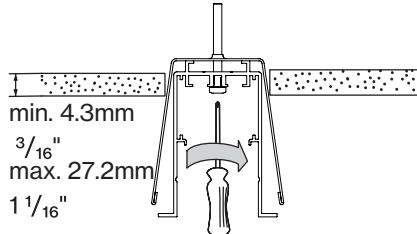
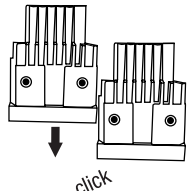
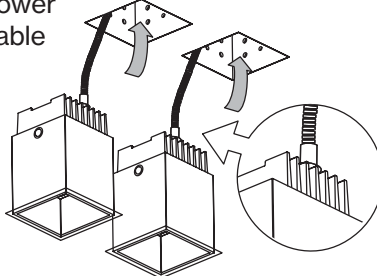
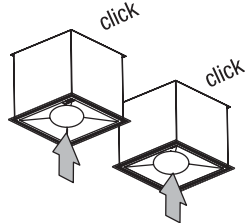
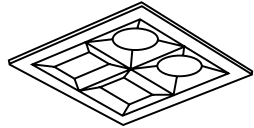
<p>1. Cut out hole in ceiling</p> 	<p>2. Flex conduit supplied by others</p> 	<p>3. Thread conduit through top of channel (conduit supplied by others)</p> 
<p>4. Insert channel into ceiling.</p>  <p>min. 4.3mm 3/16" max. 27.2mm 1 1/16"</p>	<p>5. Turn screw(s) clockwise to secure bracket(s). Repeat steps for additional channels</p>  <p>min. 4.3mm 3/16" max. 27.2mm 1 1/16"</p>	<p>6. Optional: Configurations: (see above for different housing options) Slide and click each piece together</p>  <p>click</p>
<p>7. Connect power cable</p> 	<p>8. "Click in" the lamps</p>  <p>click</p> <p>click</p>	<p>9. Installation complete</p> 

## After Sales Service Hotline

Call the XAL After Sales Hotline from Monday to Friday, 8 AM - 6 PM (EST)

Hotline:  
**+1 203 262 9990**

Or 24/7 via email:  
**service@xalusa.com**

**EN** Installation, commissioning and maintenance may only be performed by authorized and qualified personnel, taking into consideration these installation instructions and any standards and regulations applicable to the respective area of application. The electrical, mechanical and thermal suitability of the luminaire for the intended area of application must be ensured and the secure fastening of the luminaire after its installation must be controlled. Turn off supply voltage before replacing any lamps (if applicable) as well as before performing any other works on the luminaire (e.g. cleaning) and wait until luminaire and lamp have completely cooled off. Please refer to the installation notes of the lamp manufacturer when inserting, replacing and operating conventional lamps. Use a soft, damp cloth to clean the luminaire. To clean plastic components and reflectors, a standard pH neutral, alcohol-free, non-abrasive cleaning agent may also be used. Keep these installation instructions in a safe place as reference for any future maintenance works.

1. The lamp is not suitable for outdoor use.
2. The lamp may only be used with a safety guard.
3. Damaged protection glasses and covers have to be replaced immediately.
4. Corrosive chemical products must not be used as this may have a detrimental effect on the luminaire.
5. No liability is accepted for any subsequent change of the luminaire.
6. LEDs are high-quality electronic components! Please avoid touching by hand the LED light emitting surface while assembling or replacing parts and during maintenance work.
7. To avoid damage of the profile, unevenness on the wall or ceiling must be leveled out before assembling the profiles. While assembling the profiles, make sure they do not deform in order to guarantee their proper function.
8. The light source contained in this luminaire shall only be replaced by the manufacturer or his service agent or a similar qualified person.
9. The LED circuit must always be closed, before the converter is connected to the main power. XAL does not assume any liability for damages resulting from nonobservance of this rule.
10. Luminous flux and connected electrical load are subject to an initial tolerance of up to +/- 10%. Color temperature is subject to a tolerance of up to +/- 150 Kelvin from the nominal value.